

**Originalbetriebsanleitung,**  
vor der Benutzung gründlich lesen!

**Original instructions,**  
read carefully before use!

**Notice originale,**  
lire attentivement avant utilisation!

**Manual original**  
¡lea cuidadosamente antes de usar!

**Istruzioni originali,**  
leggere attentamente prima dell'uso!

**Oorspronkelijke gebruiksaanwijzing,**  
voor gebruik aandachtig lezen!

**Originální návod k obsluze,**  
před použitím si pozorně přečtěte!

**Originalna navodila za uporabo,**  
pred uporabo natančno preberite!

**Original bruksanvisning,**  
les nøye før bruk!

**Originalna uputa za uporabu,**  
pažljivo pročitajte prije upotrebe!

**Az eredeti üzemeltetési útmutató fordítása,**  
használat előtt figyelmesen olvassa el!

**Перевод руководства по эксплуатации,**  
внимательно прочитайте перед использованием!

**Tłumaczenie oryginalnej instrukcji eksploatacji,**  
przeczytaj uważnie przed użyciem!

**Originalbruksanvisning,**  
läs noga innan användning!

**Druckspritze**

**Pressure Sprayer**

**Pulvérisateur à pression**

**Pulverizador a presión**

**Spruzzatore a pressione**

**Drukspuit**

**Tlakové postřikovače**

**Tlačna škropilnica**

**Trykksprøyter**

**Prskalica pod pritiskom**

**Nyomófecskenvező**

**Распылитель давления**

**Opryskiwacz ciśnieniowy**

**Tryckspruta**

de

en

fr

es

it

nl

cs

sl

no

hr

hu

ru

pl

sv

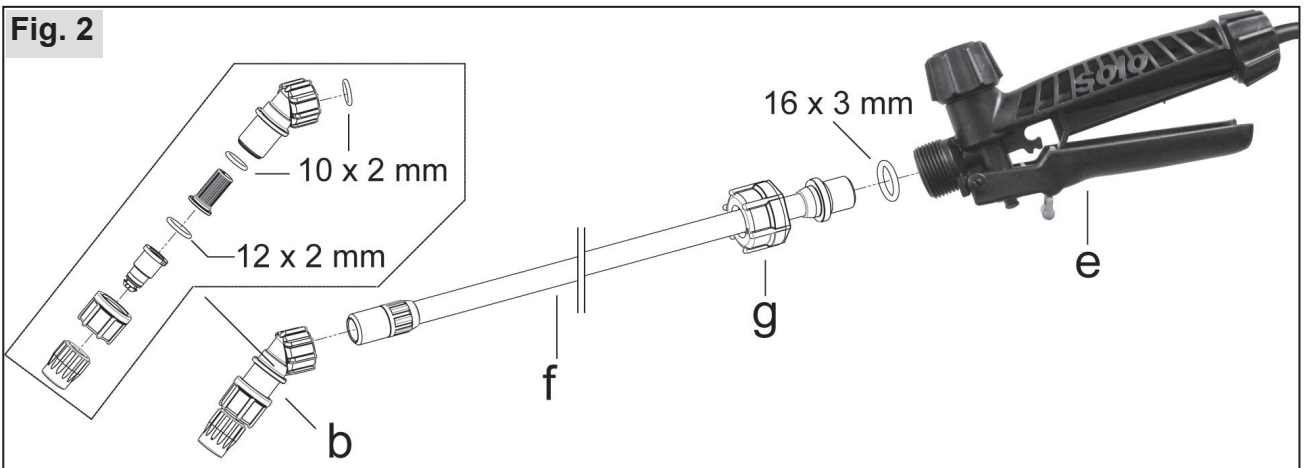

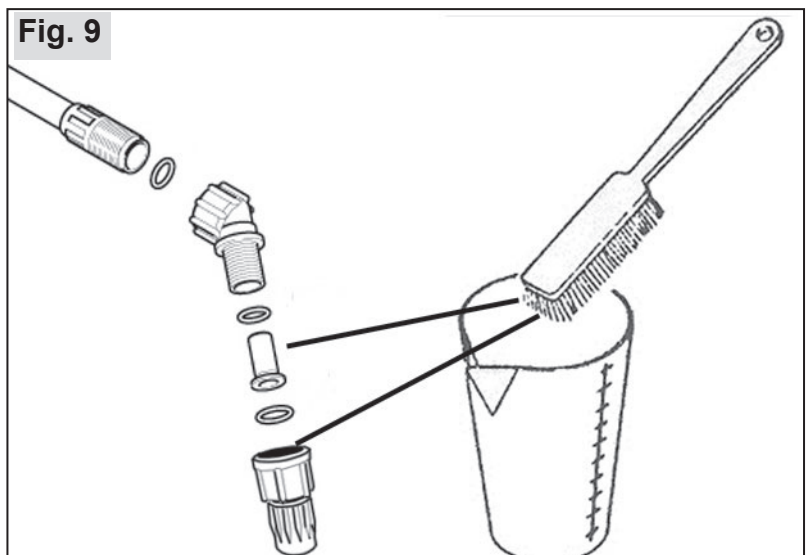

## Original instructions

Read this instruction manual carefully before first operation and strictly observe the safety regulations!

Changes to the scope of supply in form, technology and equipment are reserved. No claims can be derived from any information and figures in these original instructions.

The original packaging and, at the end of its service life, the sprayer must be properly disposed of according to the local environmental regulations. The machine can be subject to national rulings for regular review by designated offices, as specified in directive 2009/128/EC.

Information about material ingredients (VO (EC) No.1907/2006 „REACH“) can be found on our homepage under: <https://de.solo.global/de/content/12-service>

### 1 EC declaration of conformity

SOLO Kleinmotoren GmbH, Industriestraße 9, D-71069 Sindelfingen, Germany declares that the Pressure Sprayer unit type **211, 212** from production date 01/2025 onwards - corresponds to the relevant provisions of directive 2006/42/EC of the European parliament and the council from 17 May 2006 about machinery and directive 2009/127/EC.



Sindelfingen, 01 January 2025

Sascha Luft, SOLO Kleinmotoren GmbH, Industriestraße 9, D-71069 Sindelfingen (managing director and documentation officer)

### **UK** **CA** UK - DECLARATION OF CONFORMITY

We, SOLO Kleinmotoren GmbH, Industriestraße 9, D-71069 Sindelfingen, Germany declares under our sole responsibility that the products

Pressure Sprayer unit type **211, 212** to which this declaration relates is in conformity with the essential requirements and other relevant requirements of the Supply of Machinery (Safety) Regulations 2008 of the UK legislation.



Sindelfingen, 01 January 2025

Sascha Luft (CEO)

### 2 Scope of delivery

- Basic unit with hand valve and pressure hose
- Spray tube
- Pre-installed nozzle assembly incl. nozzle
- Carrying strap

### 3 Wear parts

The following wear parts are not subject to the manufacturer's guarantee:

\* All rubber parts that come into contact with spraying liquid, \* nozzles, \* filters, \* seals,

### 4 Warranty

Please observe that specific warranty conditions are valid in some countries. In doubt, ask your vendor.

No guarantee can be granted for any damage caused by:

- Non-observation of the original instructions.
- Omission of necessary maintenance and cleaning work.
- Wear and tear from regular use
- Use of unapproved working tools.
- Use of force, improper treatment, abuse or accident.
- Manipulations by non-qualified persons or from improper repair attempts.
- Unauthorized modifications to the device.
- Use of unsuitable spare parts or non-genuine spare parts.
- Use of unapproved chemicals or dilutions.
- Damage caused by use in the rental business.



Any warranty work must be performed by one of our authorised specialist vendors. Cleaning, care and standard adjustments are not accepted as warranty services.

#### For Australia only: Supplementary warranty notes specifically for Australia

To make a claim, contact Clayton Engineering, 26 French Ave, Brendale, Q, 4500 on phone 1300 798 022 or email [sales@claytonengineering.com.au](mailto:sales@claytonengineering.com.au). You will be asked to provide proof of purchase and then will be instructed on the procedure for repairing or replacement of the product under warranty. All costs incurred for repair or replace, and additional claims can be discussed at this stage.

This warranty is provided in addition to other rights and remedies you have under law: Our goods come with guarantees that cannot be excluded under the Australian Consumer Law. You are entitled to a replacement or refund for a major failure and for compensation for any other reasonably foreseeable loss or damage. You are also entitled to have the goods repaired or replaced if the goods fail to be of acceptable quality and the failure does not amount to a major failure.

## 5 Symbols

	Read the original instructions thoroughly.
	DANGER! Non-observation of the original instructions may potentially cause fatal injury.
	Wear the prescribed protective clothing.
	Wear protective gloves.
	Wear facial protection (e.g. goggles).
	Wear breathing protection.
	No smoking.
	No open fire.
	Minimum distance from other persons: 15 m [approx. 16 yards]

## 6 Safety provisions

### 6.1 Intended use / applications

- Use the device only for the application of liquid herbicides, pesticides and weed killers as well as liquid fertilisers that are available from the authorised specialist trade and approved by local/national authorities for use with portable spraying devices and for the application of clean water.
- Strictly observe the information on the spraying agent, in particular instructions on personal protective equipment.
- Application areas are in farming, tree nurseries, forest operations, orchards, vineyards, market gardens, as well as glasshouse cultures with sufficient ventilation and venting.
- The device must not be used for any other purposes, such as application of other agents from the above liquids! In particular, no acids, alkalis, solvent-containing liquids and waterproofing agents must be applied.
- Never use any liquids with temperatures above 40 °C [104 °F].
- Do not use any flammable agents.

### 6.2 General safety notes

Read the original instructions before first use and keep it in a safe place.

Non-observation of information provided in these original instructions may potentially be fatal; the user is liable for any damage, direct or consequential, caused by this.

The original instructions must be kept on hand at the site of use of the sprayer at all times.

It must be read by all who are charged with any work with and on the device (including for maintenance, care and repair).

- Have safe use shown and explained to you by a SOLO specialist vendor.
- Persons under the age of 18 must only work under supervision with this sprayer.
- Keep persons and animals away from the working area. Never spray in the direction of any persons, animals or objects that could be hurt or damaged.
- This sprayer must only be passed on to persons who are familiar with this model, its operation and the original instructions.
- If you work with this sprayer, you should be physically fit, rested and healthy.
- Do not use the sprayer while under the influence of alcohol, drugs or medication.
- Never make any changes to existing safety provisions and operating parts.
- Only use the sprayer when it is operationally safe to do so. Check the sprayer before every use according to chap. 10.1.
- Replace damaged parts without delay. Only use SOLO genuine spare parts.
- Only use factory approved accessories and attachments for this sprayer.
- Empty and clean the sprayer according to the information in chap. 10.4 for this. Prevent unauthorised access to the machine.

### 6.3 Safe handling of spraying liquids





- Follow suitable procedures and use collection containers to prevent any contamination of the environment, the public waterways and/or storm water systems from chemical agents and cleaners. This can happen while mixing, filling, using, emptying, cleaning or during transport.
- Always collect chemical spray liquids and cleaners (including residues) in suitable containers and return them to collection points specified by the municipal administration.
- In case of skin or eye contact, rinse or flush the affected body parts with plenty of clean water. Seek medical advice without delay.
- Contaminated clothing should be changed at once.
- Never eat or drink while handling spray liquids
- If you feel nauseous during work, or if you are excessively fatigued, stop working at once. If the condition persists, seek medical advice without delay.
- Never permit children or persons work with or handle spraying liquids if they are not familiar with these substances.

- Never fill different spray solutions into the spray tank.
- The description of the kind of spray solution used must be attached to the device and must be updated with every change of the spraying solution.
- When changing the spray solution, clean the spray tank and all parts that come in contact with the spray solution. Operate the sprayer with clear water first before filling the spray tank with the different spray solution.
- At the end of work, empty and clean the sprayer according to chap. 10.4, clean your face and hands thoroughly, take off work clothing and wash it regularly.

#### 6.4 When transporting the sprayer

- The device must be securely strapped down when transported on vehicles.
- Prevent leakages of spraying agents. The liquid tank of the sprayer and all liquid carrying hoses must be inspected regularly for leaks.

#### 6.5 Work clothing /personal protection equipment (PPE)

-  Suitable and approved protective clothing that protects all body parts from contact with the spray solution must be worn.
- Wear firm shoes with good gripping soles.
-  Wear protective gloves with a slip-proof palm.
-  Use facial protection (e.g. protective goggles).
-  Always wear a breathing mask when working in dense, tall plants, greenhouses, troughs or trenches and when using dangerous spraying agents.

#### 6.6 Before and during work

- Before starting work, always check the entire device for operational safety according to chap. 10.1.
- The sprayer must only be operated by one person. There must be no other person within a radius of 15m [approx. 16 yards].
- Always ensure sufficient air exchange in dense plant growth, in greenhouses, troughs or trenches.
- Always stay within calling distance from other persons that may provide help in emergency.
- Take regular working breaks to prevent fatigue.
- Do not smoke at the workplace.

#### 6.7 Maintenance, repair and storage

Only perform maintenance and repair work yourself that is described in these original instructions. All other work must be carried out by an authorised

specialist workshop.

- Do not service, repair or store the sprayer near open fire.
- Before doing any maintenance work or repairs and before opening the spraying agent tank, depressurise the device by pulling on the pressure relief valve (Fig. 4).  
Before pulling on the pressure relief valve (d), the device must always be in an upright position. Attention: Keep the device away from your face!
- The pressure hose, hand valve, spray wand and nozzle assembly must only be unscrewed when the sprayer is depressurised.

## 7 Work preparation

Fig. 1:

- a Spraying agent tank
- b Nozzle attachment
- c Pump handle
- d Pressure relief valve
- e Shut-off valve
- f Spray tube

### 7.1 Assembly

Fig. 2:

Fasten the threaded collar (g) on straight and firmly screw the spray tube (f) with O-ring (16x3 mm) hand-tight onto the shut-off valve (e). Do not use any tools!

Firmly screw the nozzle attachment (b) with the O-Ring (10x2 mm) hand-tight onto the spray tube. Do not use any tools!

Fig. 3:

When your work is completed, the spray tube should be fitted into the holding clamp at the pump handle (c).

### 7.2 Filter

The nozzle assembly (b) includes a filter insert in front of the nozzle.

The nozzle filter must always be used when working with the pressure sprayer.

### 7.3 Test run

Before its initial use, the sprayer should be tested according to chapter 10.2.

## 8 Preparing the spray liquid and filling the spray tank

Prepare the spray liquid according to the instructions of the chemical manufacturer.

Always prepare the spray liquid outdoors, never in living quarters, stables or storage rooms for food and animal feed.

Before opening the spraying agent tank, depressurise the device by pulling on the pressure relief valve (Fig. 4). Before pulling on the pressure relief valve (d), the device must always be in an upright position.

Attention: Keep the device away from your face!

#### Fig. 5:

To fill the tank with spraying agent, the pump must be unscrewed. Push the pump handle (c) down and turn it to the left (counterclockwise) until the handle clicks into position.

Unscrew the pump by turning it counterclockwise. Do not use any tools!

Fill the tank no further than to the upper-most mark on the side of the spray tank.

Max. fill volume Model 211: 5.0 l [1.32 gal]

Model 212: 7.0 l [1.85 gal]

Overfilling the tank or spills can contaminate public waterways, rain- and storm water channel and must be avoided.

Wipe off spilled spray liquid without delay.

After filling, insert the pump again and refasten firmly by turning the pump handle (c) clockwise to prevent the spraying agent from escaping.

Refasten firmly until the pump handle clicks into position.

## 9 Use of the pressure sprayer

### 9.1 Spraying

- Do not use the sprayer in wind or rain.
- Check the direction of the air movement before starting work and spray with the air movement, not against it.
- Do not spray towards persons, animals, open doors and windows, cars or other objects that may be hurt or damaged by the spray.
- Ensure that only the actual spray target will be wetted. Always aim to obtain even and homogenous distribution of the spray on the treated surfaces.

#### Pumping and spraying:

To pump, loosen the pump handle (c) by turning out of the stop position. Pump the unit until the operating pressure is reached in the spraying agent tank. Excessive pressure escapes automatically through the pressure relief valve (d).

Hold the spray wand with the hand valve.

#### Fig. 7:

To spray, depress the hand lever on the valve. Release the hand valve lever to stop spraying.

To spray the underside of leaves, lightly loosen the spray wand cap nut and turn the wand hand tighten again.

#### Nozzle adjustment (Fig. 8):

a) Nozzle closed

→ hollow cone

Delivery rate at 3 bar:

0.66 l/min [0.174 USgal/min]

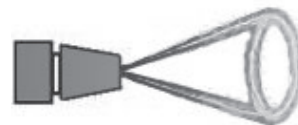

b) Nozzle open

(1/2 turn 180° until

max. 1 turn, 360°)

→ coarse and narrow jet

Delivery rate at 3 bar: 1.75 l/min [0.462 USgal/min]



An uneven spray picture or reduced spray output from the nozzle may require cleaning of the nozzle filter insert and nozzle (chap.10.4) or the replacement of these parts.

The pressure sprayer can also be carried by the pump handle (c), if the pump handle is pressed down completely, and it is turned to the right and clicked into position.

### 9.2 Disposal of residual spray volume

Residual spray volumes of less than 200 ml [6.8 oz] are no longer pumped effectively. Either add more spray formula and continue spraying or, when finishing off, dilute the residual volume with 2 litres [68 oz] of clean water and apply to the already treated area.

At the end of the work, empty and clean the sprayer according to chap. 10.4, wash face and hands thoroughly and take off the work clothing. Work clothing requires regular washing.

## 10 Maintenance, cleaning and storage

### 10.1 Maintenance plan

#### Before starting work:

- Check the entire sprayer is operationally safe by:
  - Visual inspection of the sprayer
  - Checking the tightness of all parts (at maximum admissible pressure with the hand valve opened and closed).
  - Checking the working of all functional parts (pump, hand valve).
  - Checking the hoses and their screw connections.

#### After the end of work, when changing the spray formula, whenever required:

- Cleaning the spray tank chap. 10.4
- Cleaning the nozzles and filters chap. 10.4

#### Monthly or at the start of the season, whenever required:

- Checking the output volume chap. 10.3

### 10.2 Test run

When the spraying season starts and then every month, the following items must be checked in a test run with clean water:

- Tightness of all sprayer parts at maximum admissible pressure with the hand valve opened and closed
- Function of all working parts (hand valve, pump)
- Dosage and distribution accuracy
- Calibration of output volume according to chap. 10.3

In case of irregularities, damage, leaks or limited function, do not use the sprayer but have it checked in a specialist workshop without delay.

### 10.3 Calibration of the output volume

Fill the sprayer with water to the maximum mark and spray with a working pressure of 3 bar [43 psi] for precisely one minute. Then measure the water volume required when refilling to the maximum mark. The application volume must not deviate from the indicated value (chap. 9.1) by more than 10%; otherwise, clean the nozzle and the filter insert and repeat the measurement procedure. If the application volume is not correct even after cleaning, replace the nozzle and/or filter insert.

### 10.4 Empty the spray tank and clean all the parts in the spray delivery system to the nozzle

Before opening the spraying agent tank and before disassembling the nozzle attachment, depressurise the device by pulling on the pressure relief valve (Fig. 4).

Before pulling on the pressure relief valve (d), the device must always be in an upright position.

Attention: Keep the device away from your face!

Empty the spray tank, flush with clean water all parts in the delivery system to the.

Give special attention to the wear parts such as nozzles, filters and seals.

Observe the cleaning notes in the original user manual for the chemical.

Never use any aggressive, acid- or solvent-containing cleaning agents (e.g. petrol).

After cleaning, let the spray tank dry in the open air.

Clean the spraying nozzle, filter and filling screen:

Fig. 9:

- Flush the nozzle assembly with clean water.
- Unscrew the nozzle assembly.
- Clean the O-rings, filter insert and spray nozzle with clean water and a soft brush.  
Never blow out the spray nozzle with the mouth!  
Never clean nozzles with hard objects!
- Screw the parts of the nozzle assembly back together (Fig. 2).

### 10.5 Down periods and storage

Empty and clean the sprayer according to chap. 10.4.

Keep the sprayer protected from sunlight in a dry, frost-free and secure location at a temperature of max. 35 °C [95 °F].

No open fireplaces or similar must be nearby.

Prevent unauthorised use – especially by children.

## 11 Technical data

Model		211	212
Spray tank:	Total volume), approx. Max. fill volume), approx.	approx. 6.3 l [1.66 gal] 5.0 l [1.32 gal]	approx. 9.2 l [2.43 gal] 7.0 l [1.85 gal]
Residual volume, (remaining liquid in tank that cannot be used)		< 200 ml [6.8 oz]	
Maximum permitted operating pressure		3.0 bar [43 psi]	
Permissible operating temperature		0–40 °C [32–104 °F]	
Pressure hose:	Length	1,200 mm [47.2"]	
Maximum application volume (3.0 bar [43 psi])		1.75 l/min [0.462 USgal/min]	
Filter insert:	Mesh gauge	0.8 mm [0.031"]	
Weight:	Ready for operation, empty Ready for operation, with max. filling volume	1.2 kg [2.6 lbs] 6.2 kg [13.7 lbs]	1.5 kg [3.3 lbs] 8.5 kg [18.7 lbs]
Dimensions: (without spray tube and pressure hose)	Height Width Depth	420 mm [16.5"] 200 mm [7.9"] 200 mm [7.9"]	520 mm [20.5"] 230 mm [9.1"] 240 mm [9.4"]



# **solo**<sup>®</sup>

Made in Germany



**SOLO Kleinmotoren GmbH**

Industriestraße 9 D-71069 Sindelfingen

Postfach / PO Box 60 01 52 D-71050 Sindelfingen

DEUTSCHLAND / GERMANY

Tel.: +49 (0)7031 301-0

info@solo-germany.com <http://solo.global/>